

**Digital flow ELEMENT transmitter  
for continuous flow measurement**



Type 8036 can be combined with...



**Type S030**  
INLINE fitting



**Type 2101 (8692)**  
Continuous  
TopControl system



**Type 6213**  
Solenoid valve



**Type 2030**  
On/Off Diaphragm  
valve

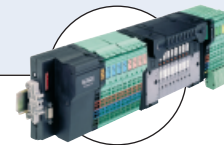

**Type 8644**  
Valve islands



**Type 8611**  
eCONTROL  
universal controller

- DN06 to DN65 fluidic process connection
- Programmable outputs : one or two transistor output(s) and single or dual 4-20 mA current output(s)
- Removable backlit display of flow and/or two totalized volumes
- Automatic-calibration: TEACH-IN, simulation of outputs signals provided without the need for real flow

The Bürkert transmitter Type 8036 is a compact device, specially designed for measuring the flow rate in solid-free liquids, in a variety of applications (water, waste water monitoring, chemical processing...).

The transmitter is made up of a compact INLINE fitting equipped of a sensor with paddle-wheel and an enclosure with cover, containing the electronic module. A removable display completes this transmitter. This ensemble (SE36) is quickly and easily connected to the fitting (S030) by a Quarter-Turn.

The flow transmitter can operate without the display, but it will be required for programming the transmitter (i.e. set parameters, restore default parameters, programme information to be displayed, programme access codes, adjust 4-20 mA output(s)...) and also for visualizing continuously the measured and processed data.

The device Type 8036 is available with:

- 2 programmable outputs : one transistor output (NPN) and one 4-20 mA current output (2-wire)
- 3 programmable outputs : two transistor outputs (NPN/PNP) and one 4-20 mA current output (2-wire)
- 4 programmable outputs: two transistor outputs (NPN/PNP) and two 4-20 mA current outputs (3-wire)

The device Type 8036 converts the measured signal, displays different values in different units (if display mounted) and computes the output signals, which are provided via one or two M12 fixed connectors. Thanks to 1 or 2 transistor outputs, the transmitter can be used to switch a solenoid valve, activate an alarm and, thanks to 1 or 2 current outputs, establish one or two control loops.

**General data**

**Compatibility**

Any pipe from DN 06 to 65 which are fitted out with Bürkert INLINE Fitting S030 (see corresponding data sheet)

**Materials**

- Housing cover
- Gaskets
- Screws
- Fixed connector mounting plate
- Fixed connector
- Display
- Navigation key
- Quarter-Turn system

See exploded view, on next page  
Stainless steel 1.4561, PPS  
PC  
EPDM  
Stainless steel  
Stainless steel 1.4404 (316L)  
Brass nickel plated  
PC  
PBT  
PC

**Display (accessories)**

Grey dot matrix 128 x 64 with backlighting

**Electrical connections**

- 2 or 3 outputs transmitter
- 4 outputs transmitters

1 x 5-pin M12 male fixed connector,  
1 x 5-pin M12 male and 1 x 5-pin M12 female fixed connectors

**Connection cable**

Shielded cable

**Environment**

**Ambient temperature**

-10 up to +60°C (32 to 140°F) (operating and storage)

**Relative humidity**

≤ 85%, without condensation

# 8036 ELEMENT Transmitter



Complete device data (Pipe + transmitter)	
<b>Pipe diameter</b>	DN 06 to 65
<b>Measuring range</b>	0.3 up to 10 m/s
<b>Medium temperature</b> with fitting in PVC PP PVDF, brass or stainless steel	0 up to 50°C (32 to 122°F) 0 up to 80°C (32 to 176°F) -15 up to 100°C (5 to 212°F)
<b>Medium pressure max.</b>	PN10 (145 PSI) (with plastic fitting) - PN16 (232 PSI) (with metal fitting) - (PN40 on request, see S030 data sheet) - see pressure / temperature chart
<b>Viscosity / Particles rate</b>	300 cSt max. / 1% max.
<b>Accuracy</b> Teach-In Standard K-factor	±1% of Reading (at Teach-In flow rate value) <sup>1)</sup> ±2.5% of Reading <sup>1)</sup>
<b>Linearity</b>	±0.5% of F.S.* <sup>1)</sup>
<b>Repeatability</b>	±0.4% of Reading <sup>1)</sup>

<sup>1)</sup> Under reference conditions i.e. measuring fluid=water, ambient and water temperature=20°C (68°F), applying the minimum inlet and outlet pipe straights, matched inside pipe dimensions.

\* F.S.=Full scale (10 m/s)

Electrical data	
<b>Power supply</b> 2 or 3 outputs transmitter (2-wire) 4 outputs transmitter (3-wire)	14-36 V DC, filtered and regulated 12-36 V DC, filtered and regulated
<b>Characteristics of the power source (not provided) of UL recognized devices</b>	Limited power source (according to § 9.3 of the UL61010-1 standard) or, Class 2 type power source (according to the 1310/1585 and 60950-1 standards)
<b>Current consumption</b> with sensor 2 or 3 outputs transmitter (2-wire) 4 outputs transmitter (3-wire)	≤ 1 A (with transistors load) ≤ 25 mA (at 14 V DC without transistors load, with current loop) ≤ 5 mA (at 12 V DC without transistors load, without current loop)
<b>Power consumption</b>	40 W max.
<b>Reversed polarity of DC</b>	Protected
<b>Voltage peak</b>	Protected
<b>Short circuit</b>	Protected for transistor outputs
<b>Output</b> Transistor 1 Transistor output (Transmitter 2-wire)  2 Transistor outputs (Transmitter 2 or 3-wire)  Current  1 Current output (Transmitter 2-wire)  2 Current outputs (Transmitter 3-wire)	NPN, open collector, 1 - 36 V DC, max. 700 mA  Configurable as sourcing or sinking (respectively both as PNP or NPN), open collector, max. 700 mA, 500 mA max. per transistor if the 2 transistor outputs are wired NPN-output: 1 - 36 V DC PNP-output: Power supply  4-20 mA programmable as sourcing or sinking (in the same mode as transistors), max. loop impedance: 1100 Ω at 36 V DC ; 610 Ω at 24 V DC; 180 Ω at 14 V DC  max. loop impedance: 1100 Ω at 36 V DC; 610 Ω at 24 V DC; 100 Ω at 12 V DC

Standards, directives and approvals	
<b>Protection class</b>	IP65, IP67, NEMA 4X and NEMA 6P with M12 cable plug mounted and tightened and cover fully screwed down
<b>Standard and directives</b> EMC Pressure Vibration / Shock <b>Approvals</b> UL-Recognized for US and Canada	EN 61000-6-2 (2005), EN 61000-6-3 (2001) Complying with article 3 of §3 from 97/23/CE. directive* EN 60068-2-6 / EN 60068-2-27  UL61010-1 + CAN/CSA-C22 No.61010-1

## Pressure / temperature chart

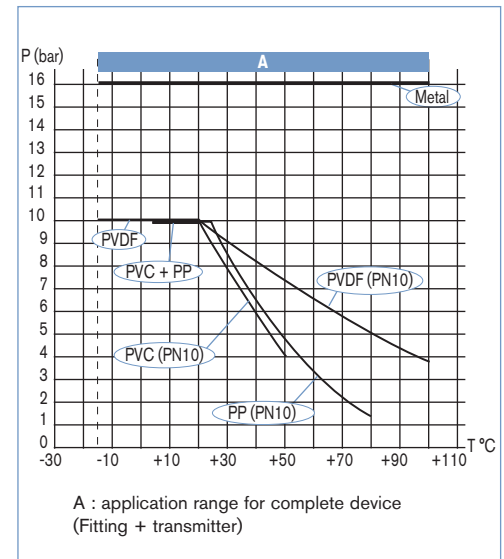

## Materials view

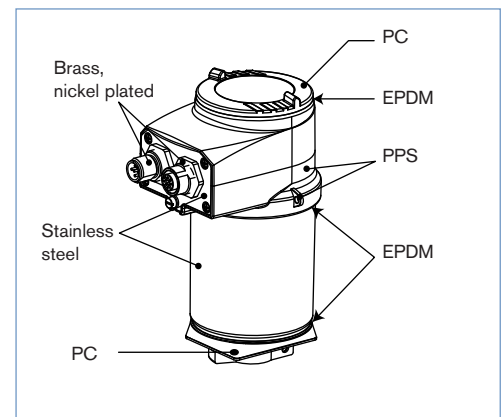

\* For the 97/23/CE pressure directive, the device can only be used under following conditions (depend on max. pressure, pipe diameter and fluid).

Type of fluid	Conditions
Fluid group 1, §1.3.a	DN ≤ 25 only
Fluid group 2, §1.3.a	DN ≤ 32 DN > 32 and PN*DN ≤ 1000
Fluid group 1, §1.3.a	PN*DN ≤ 2000
Fluid group 2, §1.3.a	DN ≤ 200

**Principle of operation**

Bürkert designed fitting (S030) ensures simple installation of the electronic housing of the 8036 into pipes from DN 06 to DN 65. The sensor with integrated paddle-wheel is mounted in the fitting. When liquid flows through the pipe, the paddle-wheel with 4 inserted magnets is set in rotation, producing a measuring signal in the sensor (Hall sensor). The frequency modulated induced voltage is proportional to the flow velocity of the fluid.

A conversion coefficient (K-factor, available in the instruction manual of the S030 fitting), specific to each pipe (size and material) enables the conversion of this frequency into volume.

The electronic component converts the measured signal into several outputs (according to the transmitter version) and displays the actual value. Counters are used to obtain the volume of fluid passed through the pipe.

**In-line installation**

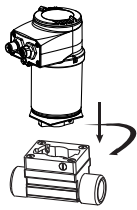

The electronic SE36 can easily be installed into any Bürkert INLINE fitting system (S030), by means of a Quarter-Turn. Minimum straight upstream and downstream distances must be observed. According to the pipe's design, necessary distances can be bigger or use a flow conditioner to obtain the best accuracy. For more information, please refer to EN ISO 5167-1.

EN ISO 5167-1 prescribes the straight inlet and outlet distances that must be complied with when installing fittings in pipe lines in order to achieve calm flow conditions. The most important layouts that could lead to turbulence in the flow are shown below, together with the associated prescribed minimum inlet and outlet distances.

These ensure calm, problem-free measurement conditions at the measurement point.

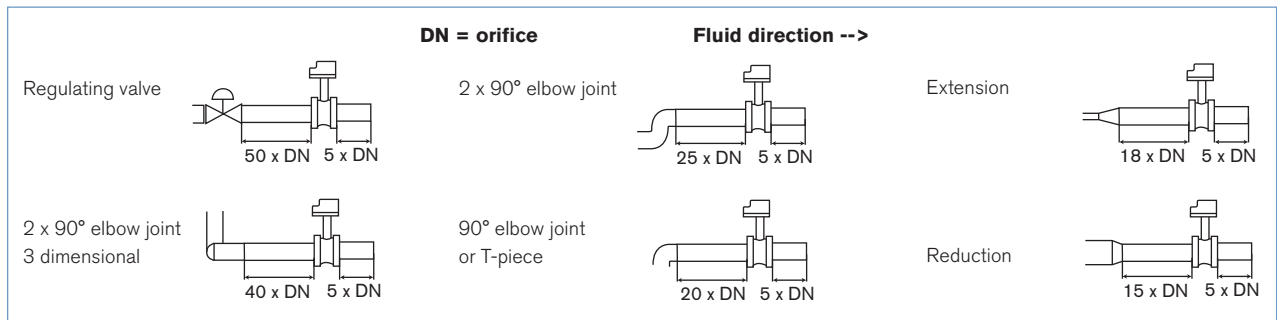

The flow rate sensor can be installed into either horizontal or vertical pipes.

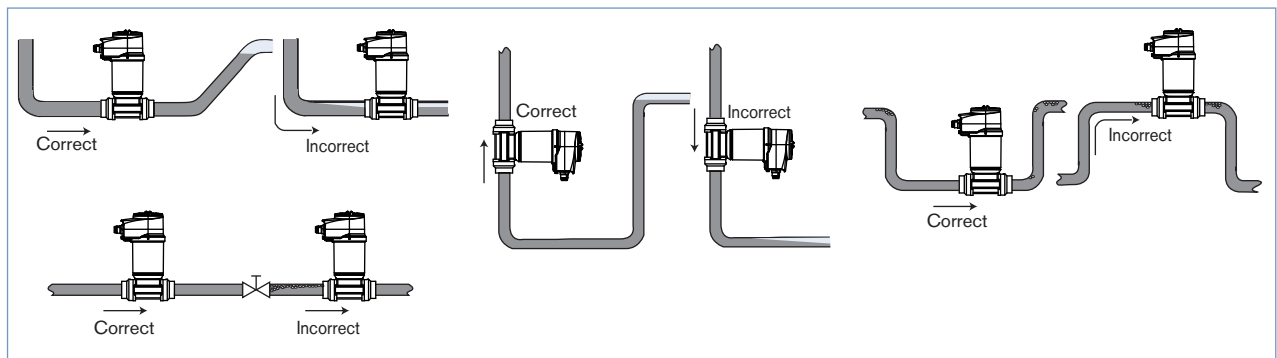

Pressure and temperature ratings must be respected according to the selected fitting material.

The suitable pipe size is selected using the diagram Flow / Velocity / DN.

The flow transmitter is not designed for gas flow measurement.

Selection of fitting / pipe size

**Example:**

- Specification of nominal flow: 10 m<sup>3</sup>/h
- Ideal flow velocity: 2...3 m/s

For these specifications, the diagram indicates a pipe size of DN40 [or DN50 for (\*) mentioned fittings]

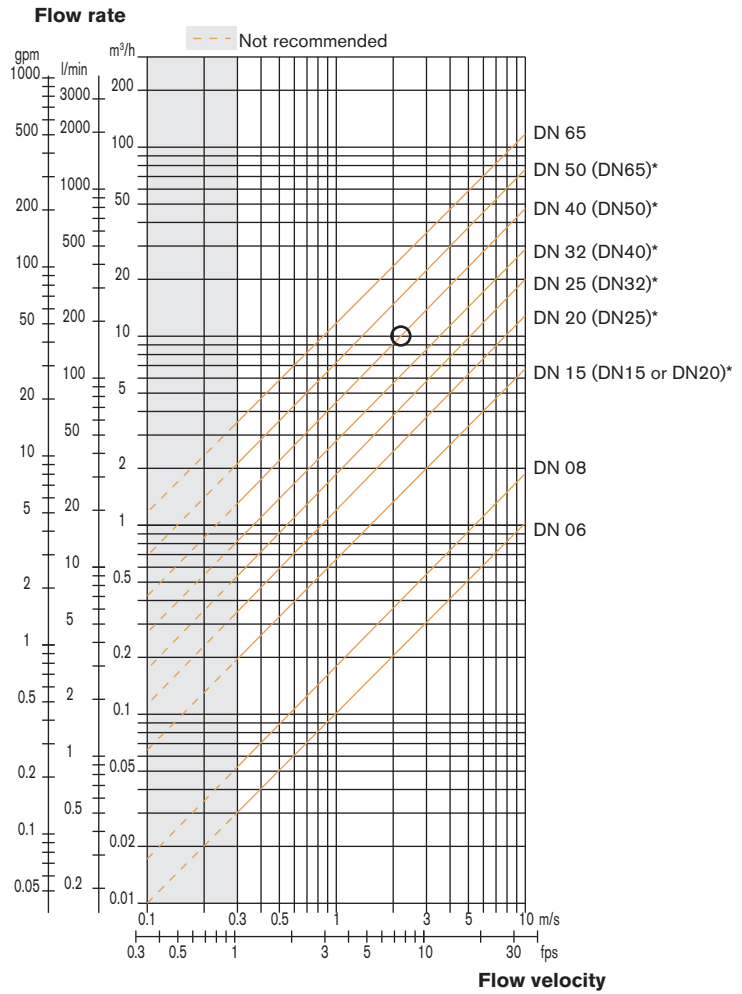

- \* For following fittings:
- with external threads acc. to SMS 1145
  - with weld-ends acc. to SMS 3008, BS 4825 / ASME BPE or DIN 11850 Series 2
  - with Clamp acc. to SMS 3017 / ISO 2852, BS 4825 / ASME BPE or DIN 32676

Dimensions [mm] of transmitter Type 8036

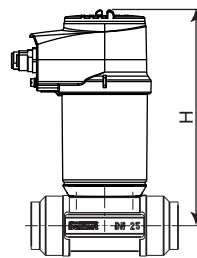
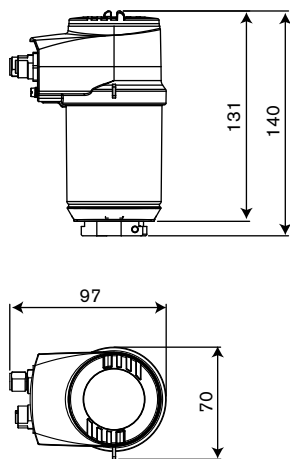

DN	H with S030 fitting
06	160
08	160
15	165
20	163
25	163
32	166
40	170
50	177
65	177

**Ordering information for compact transmitter Type 8036**

A complete flow transmitter Type 8036 consists of a compact flow ELEMENT transmitter Type SE36, a removable display/programmer and a Bürkert INLINE fitting Type S030

The following information is necessary for the selection of a complete device:

- **Item no.** of the desired compact flow transmitter **Type SE36** (see ordering chart on p. 6)
- **Item no.** of the selected INLINE fitting **Type S030** (see separate data sheet)









You have always to order separately two components.

**Attention!**

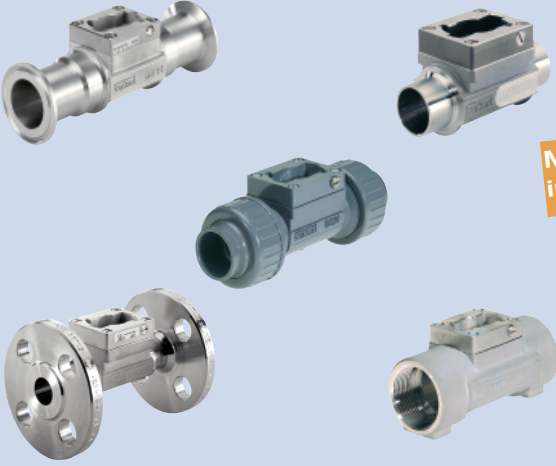

When you order devices without display, please take care that you also order at least one display module for the operation.  
Order no. of the removable display / programming module (see ordering chart on p. 6)

When you click on the orange box "More info." below, you will come to our website for the resp. product where you can download the data sheet.

**Example**

<p><b>Compact transmitter without display Type SE36</b></p>   <p><b>Compact transmitter without display Type SE36</b> + <b>Removable display/programmer</b></p>    <p><b>INLINE fitting Type S030</b></p>  <p><b>More info.</b></p>	<p><b>Complete flow transmitter Type 8036</b></p>     
---	--





Ordering chart for compact transmitter Type SE36

Specifications	Voltage supply	Output	Electrical connection	UL Approval	Item no.	
					without display	with display
2 outputs	14-36 V DC	1 x transistor NPN + 1 x 4-20 mA (2-wire)	5-pin M12 male fixed connector	No	560 880	561 880
				 Recognized	560 883	561 883
3 outputs	14-36 V DC	2 x transistors NPN/PNP + 1 x 4-20 mA (2-wire)	5-pin M12 male fixed connector	No	560 881	561 881
				 Recognized	560 884	561 884
4 outputs	12-36 V DC	2 x transistors NPN/PNP + 2 x 4-20 mA (3-wire)	5-pin M12 male and 5-pin M12 female fixed connectors	No	560 882	561 882
				 Recognized	560 885	561 885

**Note: Order separately (see accessories)**

- M12 cable plugs (only female for single 4-20 mA, 1 male + 1 female for dual 4-20 mA transmitter)

Ordering chart for accessories

Description	Item no.
Removable display/programmer module (with instruction sheet)	559 168
Black blank cover with seal	560 948
Transparent cover with EPDM seal	561 843
 5 pin M12 female straight cable plug with plastic threaded locking ring, to be wired	917 116
 5 pin M12 male straight cable plug with plastic threaded locking ring, to be wired	560 946
 5 pin M12 female straight cable plug moulded on cable (2 m, shielded)	438 680
 5 pin M12 male straight cable plug moulded on cable (2 m, shielded)	559 177

Interconnection possibilities with other Bürkert devices

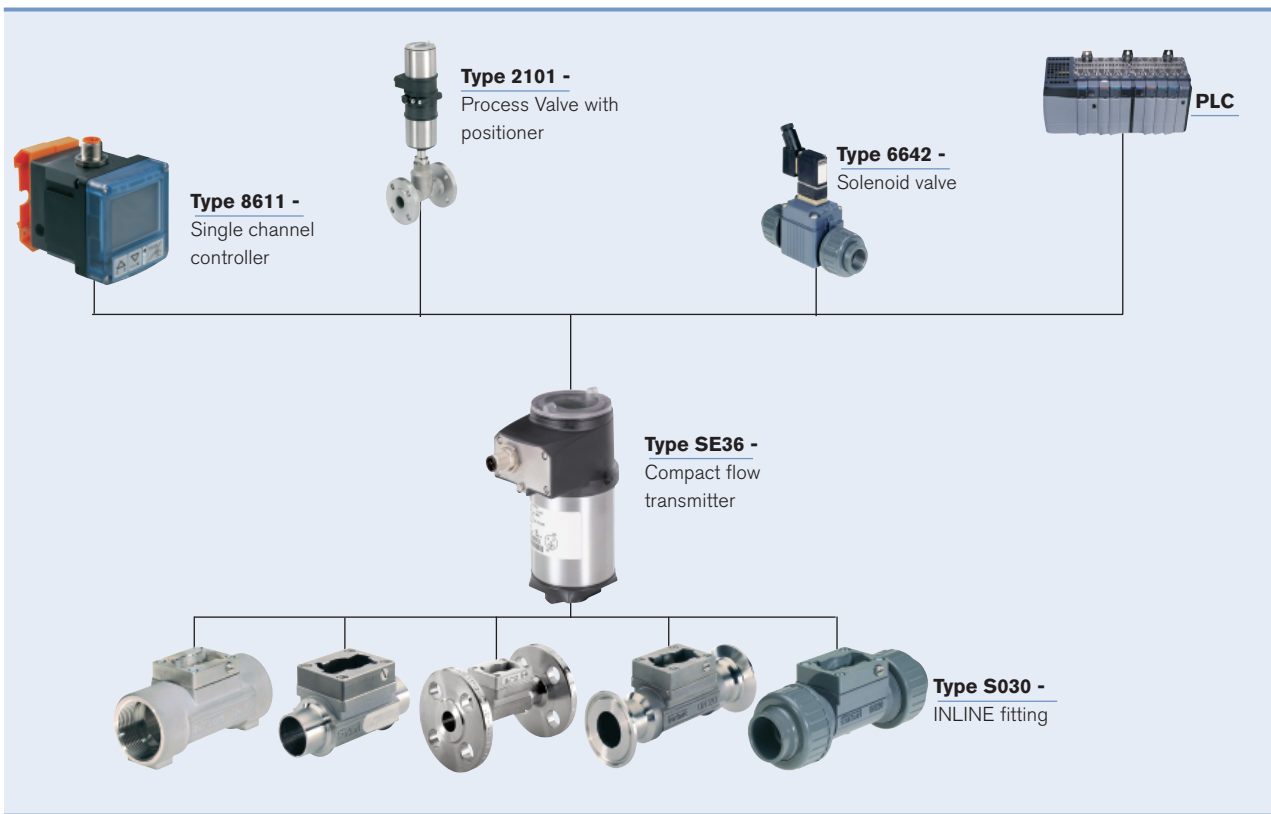

DTS 1000128709 EN Version: D validé printed: 27.07.2011 Status: RL (released | freigegeben |

To find the nearest Bürkert, click on the orange box →

[www.burkert.com](http://www.burkert.com)

In case of special application conditions,  
please consult for advice.

Subject to alteration  
© Christian Bürkert GmbH & Co. KG

1010/3\_EU-en\_00895130