

INLINE flow sensor for continuous flow measurement



Type 8030 can be combined with...



Type 8025

Flow transmitter
remote version

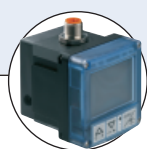

Type 8611

PI flow
controller



Type 2712 (8630)

Continuous
TopControl system

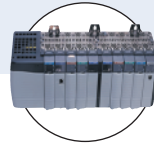

PLC

- Economic integration in pipe systems without any additional piping
- 3-wire frequency pulse version to directly interface with PLC's (both PNP and NPN)
- Connection to Bürkert devices in remote versions

The paddle-wheel flow sensor for continuous flow measurement is especially designed for use in neutral, slightly aggressive, solid free liquids. The sensor is made up of a compact fitting (S030) and an electronic module (SE30) quickly and easily connected together by a Quarter-Turn. The Bürkert designed fitting system ensures simple installation of the sensors into all pipes from DN 06 to 65. The sensor produces a frequency pulse signal, proportional to the flow rate, which can easily be transmitted and processed by a Bürkert remote transmitter / indicator (Type 8025/8032).

Technical data

General data

Compatibility	With fittings S030 (see corresponding data sheet)
Materials	
Housing, cover	PC
Cable plug	PA
Materials wetted parts	
Fitting, sensor armature	Brass, stainless steel 1.4435/316L, PVC, PP, PVDF
Paddle-wheel	PVDF
Axis, bearing / Seal	Ceramics / FKM (EPDM option)
Electrical connection	Cable plug EN 175301-803
Connection cable	1.5 mm ² cross section; max. 50 m length, shielded

Complete device data (fitting + electronic module)

Pipe diameter	DN 06 to 65
Measuring range	0.3 to 10 m/s
Fluid temperature with	
PVC fitting / PP fitting	0 up to 50°C (32 to 122°F) / 0 up to 80°C (32 to 176°F)
St. st., brass, PVDF fitting	-15 up to 100°C (5 to 212°F)
Fluid pressure max.	PN10 (with plastic fitting) PN16 (with metal fitting) (PN 40 on request, see S030 data sheet)
Viscosity / solid particles rate	300 cSt. max. / max. 1% (Size of particles 0.5 mm max.)
Accuracy	
Teach-In	≤ ± 0.5% of F.S.* (at 10 m/s) ¹⁾
Standard K-factor	≤ ± (0.5% of F.S.* + 2.5% o. Reading) ¹⁾
Linearity	≤ ± 0.5% of F.S.* (at 10 m/s) ¹⁾
Repeatability	≤ 0.4% of Reading ¹⁾
Environment	
Ambient temperature	-15 up to + 60°C (5 to 140°F) (operating and storage)
Relative humidity	≤ 80%, without condensation

* F.S. = Full scale (10 m/s)

1) Under reference conditions i.e. measuring fluid = water, ambient and water temperature = 20°C (68°F), applying the minimum inlet and outlet pipe straights, matched inside pipe dimensions.

Electrical data	
Power supply	12-36 V DC (via Bürkert transmitter for "Low Power" version)
Current consumption	with sensor
Pulse version	≤ 30 mA
Pulse "Low power" version	≤ 0.8 mA
Output: Frequency	
Pulse version	Transistor NPN/PNP, open collector, max. 100 mA, frequency: 0...300 Hz; duty cycle 1/2
Pulse "Low Power" version	Transistor NPN, open collector, max. 10 mA, frequency: 0...300 Hz; duty cycle 1/2
Reversed polarity of DC	Protected
Standards and approvals	
Protection class	IP65 with connector plugged-in and tightened
Standard and directives	
EMC	EN 61000-6-2, 61000-6-3
Pressure	Complying with article 3 of §3 from 97/23/CE directive.*
Vibration	EN 60068-2-6
Shock	EN 60068-2-27

* For the 97/23/CE pressure directive, the device can only be used under following conditions (depend on max. pressure, pipe diameter and fluid).

Type of fluid	Conditions
Fluid group 1, §1.3.a	DN ≤ 25 only
Fluid group 2, §1.3.a	DN ≤ 32 or DN > 32 and PN*DN ≤ 1000
Fluid group 1, §1.3.b	PN*DN ≤ 2000
Fluid group 2, §1.3.b	DN ≤ 200

Design and principle of operation

The flow sensor 8030 is built up with an electronic module SE30 associated to a fitting S030 with integrated measurement paddle-wheel. This connection is made by means of a Quarter-Turn.

In a 3-wire system, the signal can be displayed or processed directly. The output signal is provided via cable plug according to EN 175301-803.

When liquid flows through the pipe, the paddle-wheel is set in rotation, producing a measuring signal in the transducer. The frequency modulated induced voltage is proportional to the flow velocity of the fluid.

A conversion coefficient (K-factor, available in the instruction manual of the fitting), specific to each pipe (size and material) enables the conversion of this frequency into flow rate.

Two electronic module versions with frequency output are available:

- with one pulse output (either NPN or PNP transistor output depending on wiring).

An external power supply of 12-36 V DC is required. It is designed for connection to any system with open collector NPN or PNP frequency input.

- with one pulse "Low Power" output (NPN transistor output).

An external power supply of 12-36 V DC is required. Can only be connected to separate versions of flow transmitters Type 8025/8032.

Installation



The 8030 flow sensor can easily be installed into any Bürkert INLINE fitting system Type S030, by means of a Quarter-Turn. Minimum straight upstream and downstream distances must be observed. According to the pipe's design, necessary distances can be bigger or use a flow conditioner to obtain the best accuracy. For more information, please refer to EN ISO 5167-1.

EN ISO 5167-1 prescribes the straight inlet and outlet distances that must be complied with when installing fittings in pipe lines in order to achieve calm flow conditions. The most important layouts that could lead to turbulence in the flow are shown below, together with the associated prescribed minimum inlet and outlet distances. These ensure calm, problem-free measurement conditions at the measurement point.

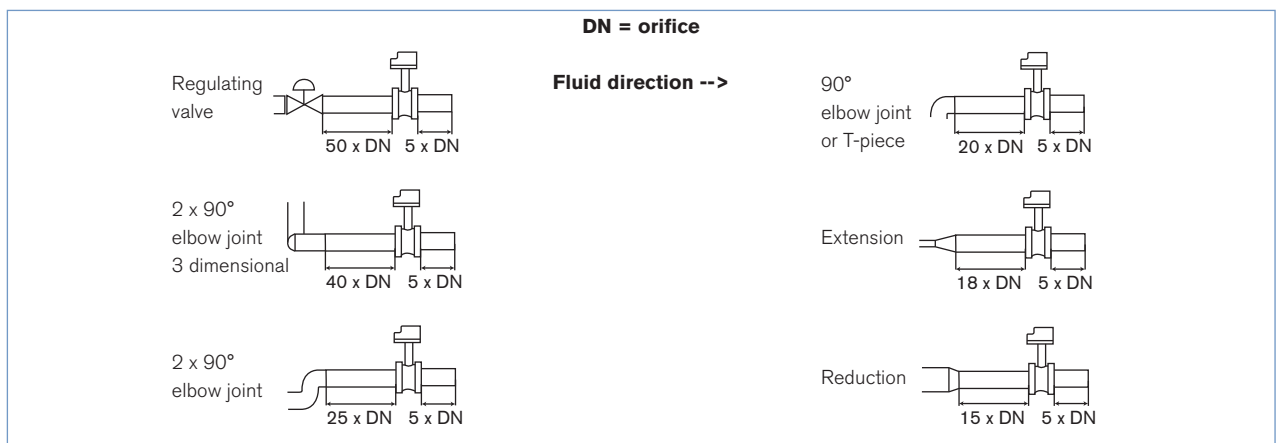

Installation (continued)

The flow rate sensor can be installed into either horizontal or vertical pipes.

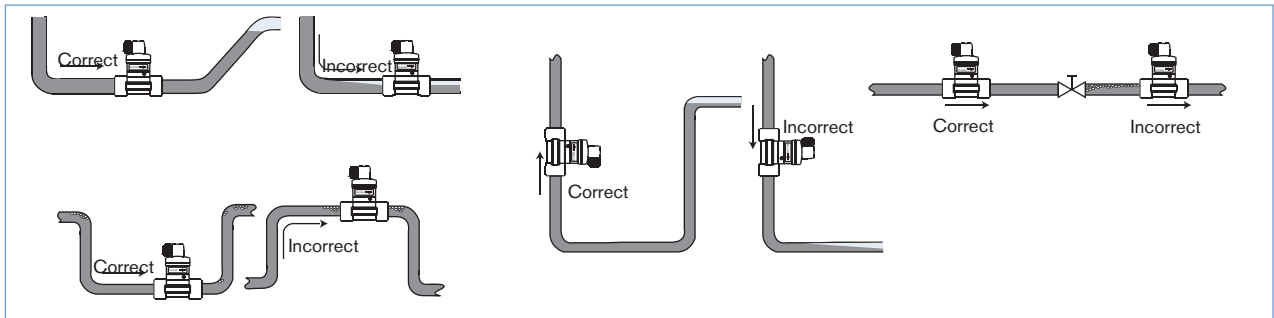

Pressure and temperature ratings must be respected according to the selected fitting material. The suitable pipe size is selected using the diagram Flow / Velocity / DN.

The sensor is not designed for gas flow measurement.

Selection of fitting / pipe size

Example:

- Specification of nominal flow: 10 m³/h
- Ideal flow velocity: 2...3 m/s
- For these specifications, the diagram indicates a pipe size of DN40 [or DN50 for (*) mentioned fittings]

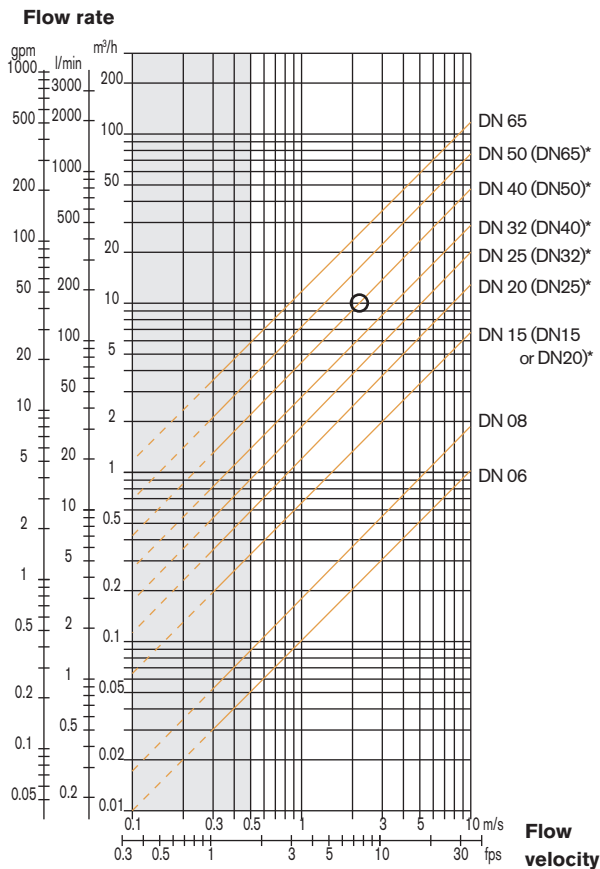

* for following fittings:
 - with external threads acc. to SMS 1145
 - with weld-ends acc. to SMS 3008, BS 4825 / ASME BPE or DIN 11850 Series 2
 - Clamp acc. to SMS 3017 / ISO 2852, BS 4825 / ASME BPE or DIN 32676

Dimensions

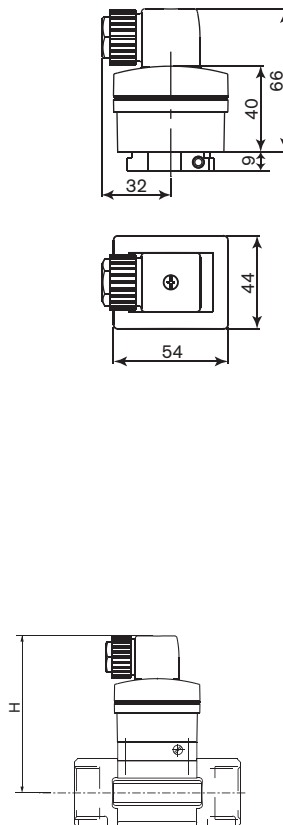

DN [mm]	H [mm]
06	95.5
08	95.5
15	100.5
20	98.0
25	98.0
32	102.0
40	105.5
50	112.0

Ordering chart for sensor Type 8030

A flow sensor Type 8030 consists of: - a sensor electronic module Type SE30
 - an INLINE fitting Type SO30 (DN06 - DN65) (Refer to corresponding data sheet)

Description	Voltage supply	Output	Electrical connection	Item no.
Pulse version sensor (pluggable to Types 8025 Universal transmitter, batch controller or konti-Dos; 8032; PLC)	12-36 V DC	Frequency with pulse, PNP or NPN	Cable plug EN 175301-803	423 913
Pulse "Low Power" version sensor (pluggable to Types 8025, 8032 remote version)	from associated transmitter	Frequency with pulse, NPN	Cable plug EN 175301-803	423 914

Ordering chart for accessories (to be ordered separately)

Specifications	Item no.
Cable plug EN 175301-803 with cable gland (Type 2508)	438 811
Cable plug EN 175301-803 with NPT1/2 " reduction without cable gland (Type 2509)	162 673

Interconnection possibilities with the sensor Type 8030-HT

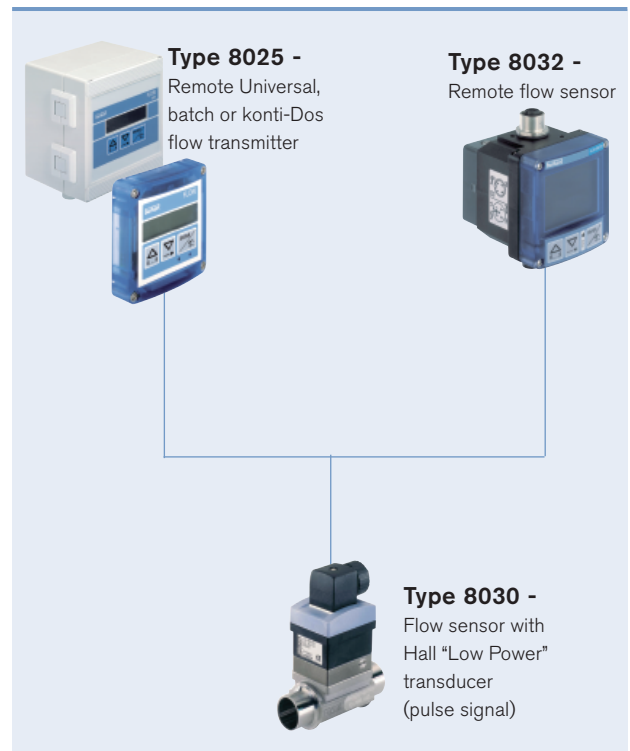
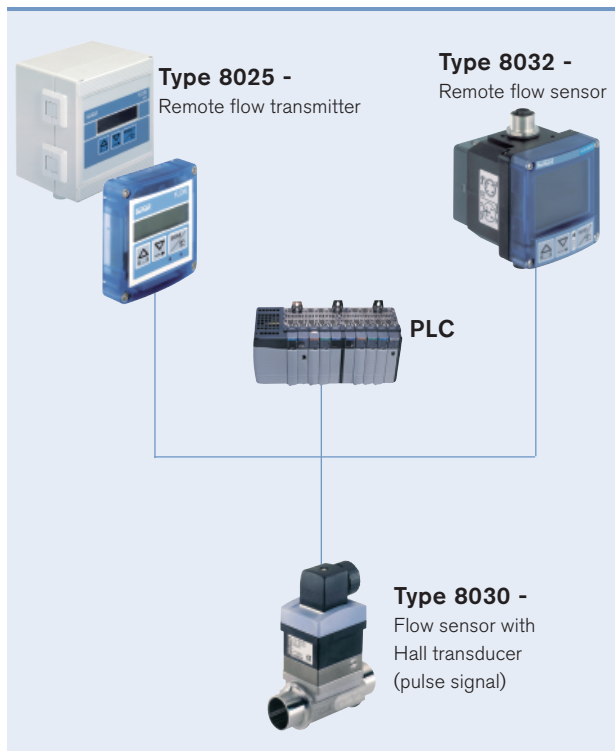

To find your nearest Bürkert facility, click on the orange box →

www.burkert.com

In case of special application conditions, please consult for advice.

Subject to alteration.
 © Christian Bürkert GmbH & Co. KG

0908/9_EU-en_00891778

DTS 1000011081 EN Version: N Status: RL (released | freigegeben | validé) printed: 27.07.2011